



Retroreflective sensor ML100-6-IR/102/115



- User-friendliest photoelectric sensor series for standard applications
- Miniature design
- Not sensitive to ambient light
- Metal-reinforced fastening holes
- Version with infrared light

Retroreflective sensor without polarization filter, plastic housing, 5 m detection range, infrared light, sensitivity adjuster, light/dark on, DC version, NPN output, fixed cable



Function

Small, robust and reliable, the ML8 series of miniature sensors is particularly suitable for non-contact detection of objects in confined spaces. The LED indicator is located behind the lens and provides reliable information on the sensor's operating status. The LED is always visible, even if the sensor is completely embedded. Flexible mounting options and fixed preset detection ranges simplify setup and operation.

Dimensions

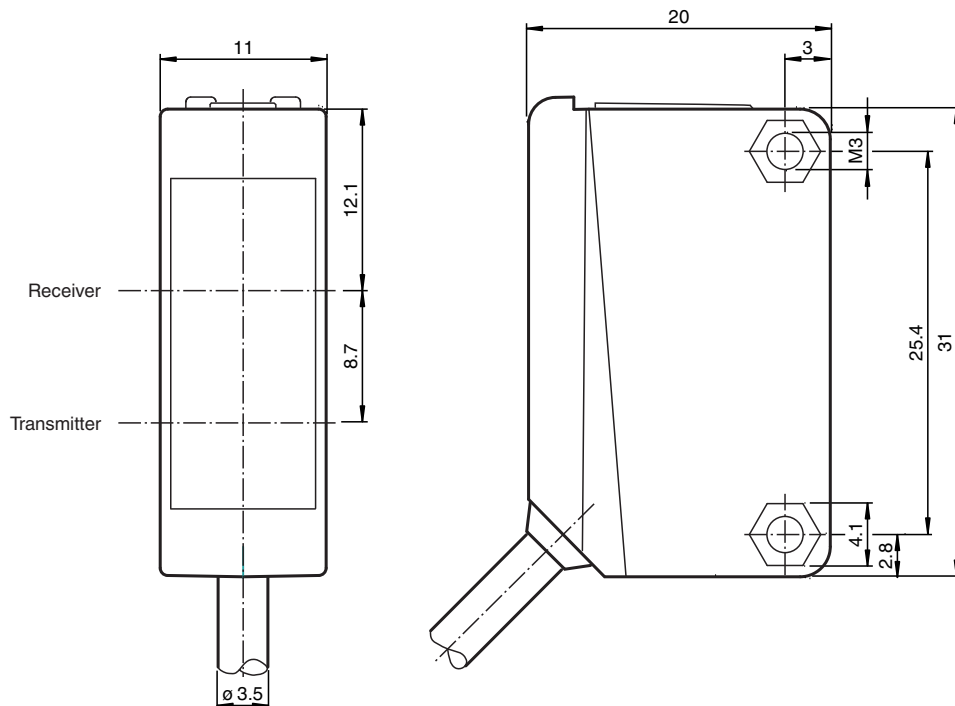

Release date: 2021-03-25 Date of issue: 2021-03-25 Filename: 224751_eng.pdf

Refer to "General Notes Relating to Pepperl+Fuchs Product Information".

Pepperl+Fuchs Group
www.pepperl-fuchs.com

USA: +1 330 486 0001
fa-info@us.pepperl-fuchs.com

Germany: +49 621 776 1111
fa-info@de.pepperl-fuchs.com

Singapore: +65 6779 9091
fa-info@sg.pepperl-fuchs.com

PF PEPPERL+FUCHS

Technical Data

General specifications		
Effective detection range		0 ... 5 m
Reflector distance		0.01 ... 5 m
Threshold detection range		7 m
Reference target		H50 reflector
Light source		IRED
Light type		modulated infrared light
Polarization filter		no
Diameter of the light spot		approx. 500 mm at a distance of 7 m
Angle of divergence		approx. 4 °
Optical face		frontal
Ambient light limit		EN 60947-5-2:2007+A1:2012
Functional safety related parameters		
MTTF _d		860 a
Mission Time (T _M)		20 a
Diagnostic Coverage (DC)		0 %
Indicators/operating means		
Operation indicator		LED green: power on
Function indicator		LED yellow: lights up when receiving the light beam ; flashes when falling short of the stability control; OFF when light beam is interrupted
Control elements		sensitivity adjustment
Control elements		Light-on/dark-on changeover switch
Electrical specifications		
Operating voltage	U _B	10 ... 30 V DC
Ripple		max. 10 %
No-load supply current	I ₀	< 20 mA
Output		
Switching type		The switching type of the sensor is adjustable. The default setting is: light-on
Signal output		1 NPN output, short-circuit protected, reverse polarity protected, open collector
Switching voltage		max. 30 V DC
Switching current		max. 100 mA , resistive load
Voltage drop	U _d	≤ 1.5 V DC
Switching frequency	f	1000 Hz
Response time		0.5 ms
Conformity		
Product standard		EN 60947-5-2
Approvals and certificates		
UL approval		cULus Listed, Class 2 Power Source or listed Power Supply with a limited voltage output with (maybe integrated) fuse (max. 3.3 A according UL248), Type 1 enclosure
CCC approval		CCC approval / marking not required for products rated ≤36 V
UN/ECE Regulation No. 10 (E1)		Type-approval number: 047350
Ambient conditions		
Ambient temperature		-30 ... 60 °C (-22 ... 140 °F)
Storage temperature		-40 ... 70 °C (-40 ... 158 °F)
Mechanical specifications		
Housing width		11 mm
Housing height		31 mm
Housing depth		20 mm
Degree of protection		IP67
Connection		fixed cable
Material		
Housing		PC (Polycarbonate)
Optical face		PMMA
Mass		approx. 50 g

Release date: 2021-03-25 Date of issue: 2021-03-25 Filename: 224751_eng.pdf

Technical Data

Tightening torque, fastening screws	0.6 Nm
Cable length	2 m

Connection

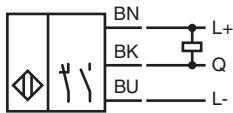

Assembly

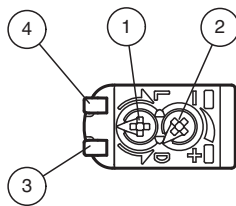

1	Light-Dark-switching	
2	Sensitivity adjuster	
3	Signal display	yellow
4	Operating display	green

Characteristic Curve

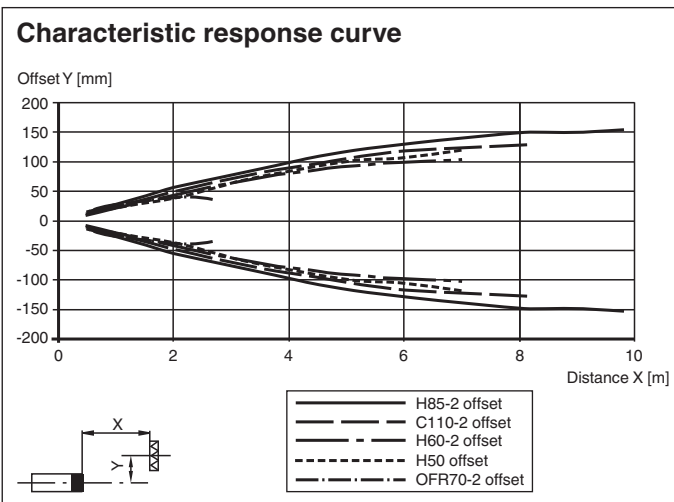

Release date: 2021-03-25 Date of issue: 2021-03-25 Filename: 224751_eng.pdf

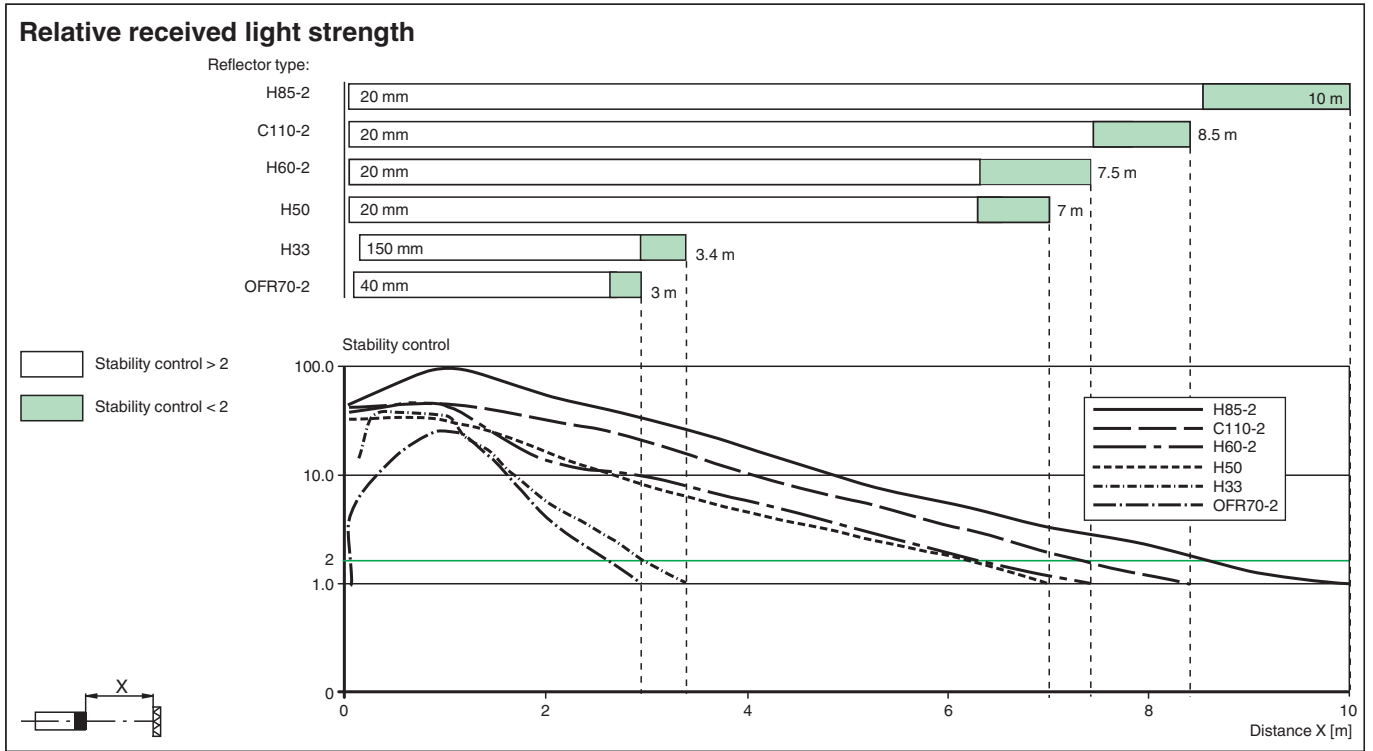

Application







Accessories

	OMH-ML100-09	Mounting aid for round steel \varnothing 12 mm or sheet 1.5 mm ... 3 mm
	OMH-ML100-01	Mounting aid for ML100 series, mounting bracket
	OMH-ML100-02	Mounting aid for ML100 series, mounting bracket
	OMH-ML100-04	Mounting aid for ML100 series, mounting bracket
	OMH-ML100-05	Mounting aid for ML100 series, mounting bracket

Release date: 2021-03-25 Date of issue: 2021-03-25 Filename: 224751_eng.pdf

Accessories

	OMH-F10-ML100	Mounting aid for ML100 series
	OMH-10	Mounting aid
	OMH-ML100-03	Mounting aid for round steel \varnothing 12 mm or sheet 1.5 mm ... 3 mm
	REF-H33	Reflector with screw fixing